

ZHENGZHOU LEHENG ELECTRONIC TECHNOLOGY CO.,LTD

SPECIFICATION FOR APPROVAL

CUSTOMER: IOT

PART NAME: 4G Magnet Antenna

Supplier PN: GL088

Date: June 26th,2024

Q'TY: 5K/21K

CUSTOMER APPROVED BY		
APPROVAL	CHIEF	SUPERVISOR

SUPPLIER SIGNATURE		
APPROVAL	CHECK	DESIGN
Jammy	Jerry	Patrick

Add: Room 816-818, Block B,BLDG 18, University Science Park(East), Zhengzhou

City,P.R.Henan,China. Zip Code: 450051

Tel: 86-371-60911368 Email: info@global-antenna.com Web: <https://www.asialeren.com>

ZHENGZHOU LEHENG ELECTRONIC TECHNOLOGY CO.,LTD

Admission book item table

NO.	Contents	Number of Page	Page Code
1	Spec Cover	1	1
2	Spec Item	1	2
3	Product pictures	1	3
4	Specifications	1	4
5	Drawing	1	5
6	Packing data	1	6
7	Test Reports	1	7

ZHENGZHOU LEHENG ELECTRONIC TECHNOLOGY CO.,LTD

Electrical Properties	
Frequency	704-880;960-1710;1880-1990;2100-2700MHz
Impedance	50ohm Nominal
VSWR	3.0MAX
GAIN	3.5DBI
Power max.	10V
Connector	SMA PLUG
Antenna installation method:	1. 3M adhesive 2. Lock screw
Physical Properties	
Antenna Material	Antenna Cover : Tpe Antenna Base : ABS
Cable Type	RG-174 CABLE
Operating Temp.	-40~ +85 C
Storage Temp.	+45 ~ +85。 C
Cable Color	BLACK



Product Picture



ROHS

REV.	CONTENT	DATE
A	首次发行	2015.05.25

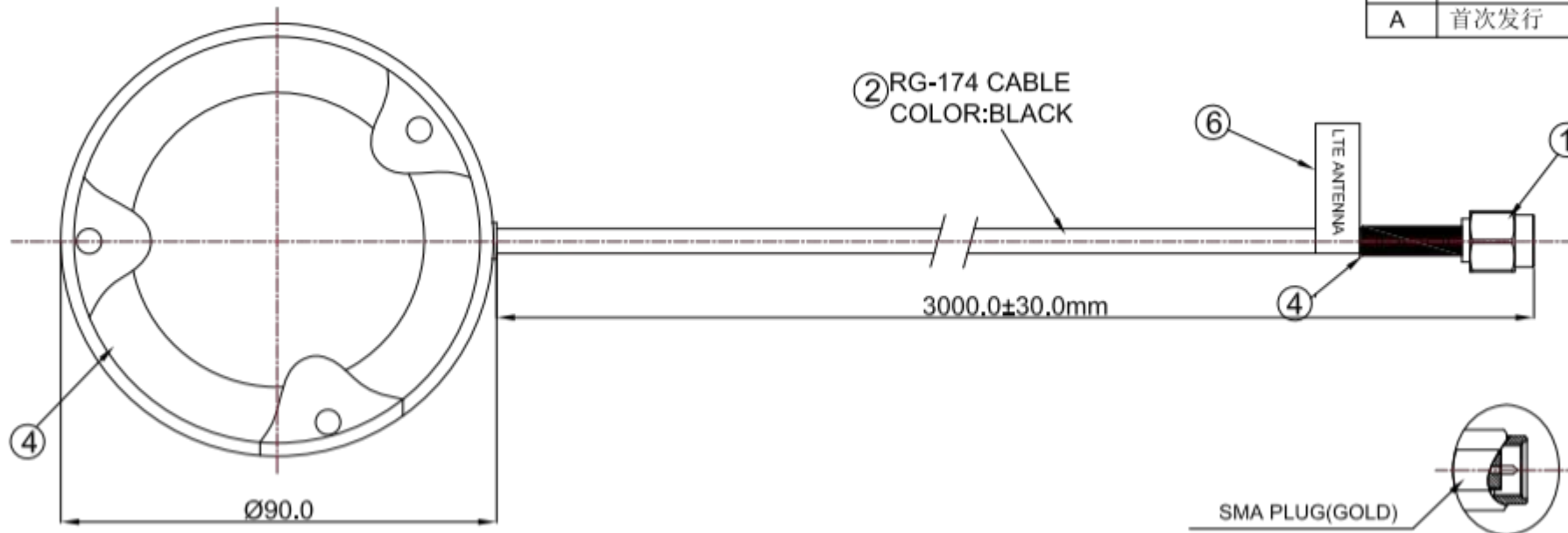

Specification:
 4G Frequency Rang:
 704-880;960-1710;1880-1990;2100-2700MHz
 VSWR:3.0MAX
 GAIN:3.5DBI
 Impedance values:50 Ohm
 Connector:SMA PLUG(可由客户指定)

The antenna installation method:
 1. The paste
 2. Lock screw

NO.	Name	Finished	Q'ty
6	LABEL	Product Label	1PC
5	EVA	Red EVA foam rubber, OD90.0 * 1.0 mm	1PC
4	Plastic cover	Antenna plastic cover	1PC
3	TUBE	Heat shrinkable tube Φ 4.0 mm UL/CSA black	1PC
2	CABLE	RG174 Cable, Coaxial line (black)	1PC
1	CONN	SMA PLUG FOR RG-174 CABLE	1PC

		TOLERANCE UNLESS OTHERWISE SPECIFIED		CUSTOMER	
		UNIT:mm		ZHENGZHOU LEHENG ELECTRONIC TECHNOLOGY CO.,LTD	
		SHEET: 1/1		PART NO: GL088	
		SCALE: 1/1		TITLE: 4G MagnetAntenna RG174-3m SMA male	
ANGLES ±0.5° X. ±2.0 X.XX ±0.2 XX. ±5.0		S.H P/NO		S.H P/NO	
DATE:2015-05-25		SIZE: A4	DRAWN: Patrick	CHECKED: Jerry	APPROVED: Jammy

Packing rules

Part number	GL088	Version	
Product name	4G magnet antenna L=3.0M	Client	
Packing procedures and specifications are as follows:			
1.product picture		2.Antenna single PCS package	
			
3.XXX PCS is packed in one box and can be packed according to the order quantity and the number of boxes		4. Place in a carton, tie the tape and label accordingly	
			



Measurement

S-Parameters

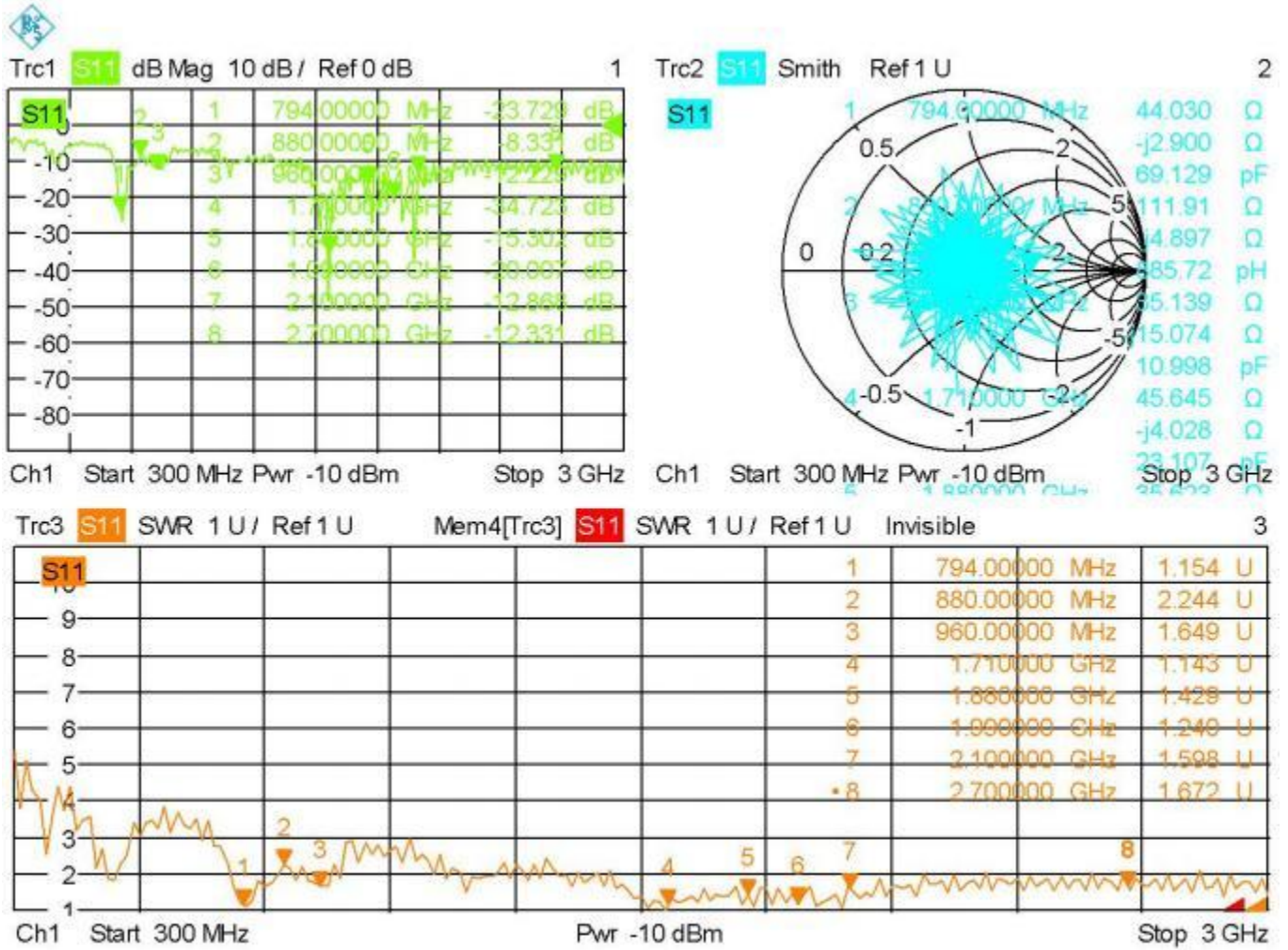

Date: 18.MAY.2015 17:04:00

RoHS

REV.	CONTENT	DATE
A	首次发行	2022.04.27

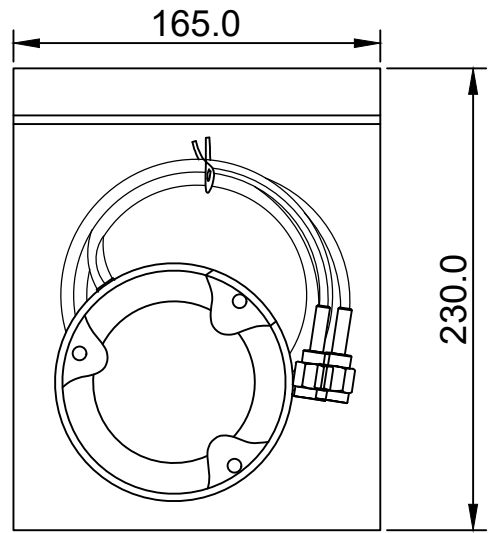

1PC/PE bag

15PCS/PE BAG/350*450mm
2 bags/30PCS/layer

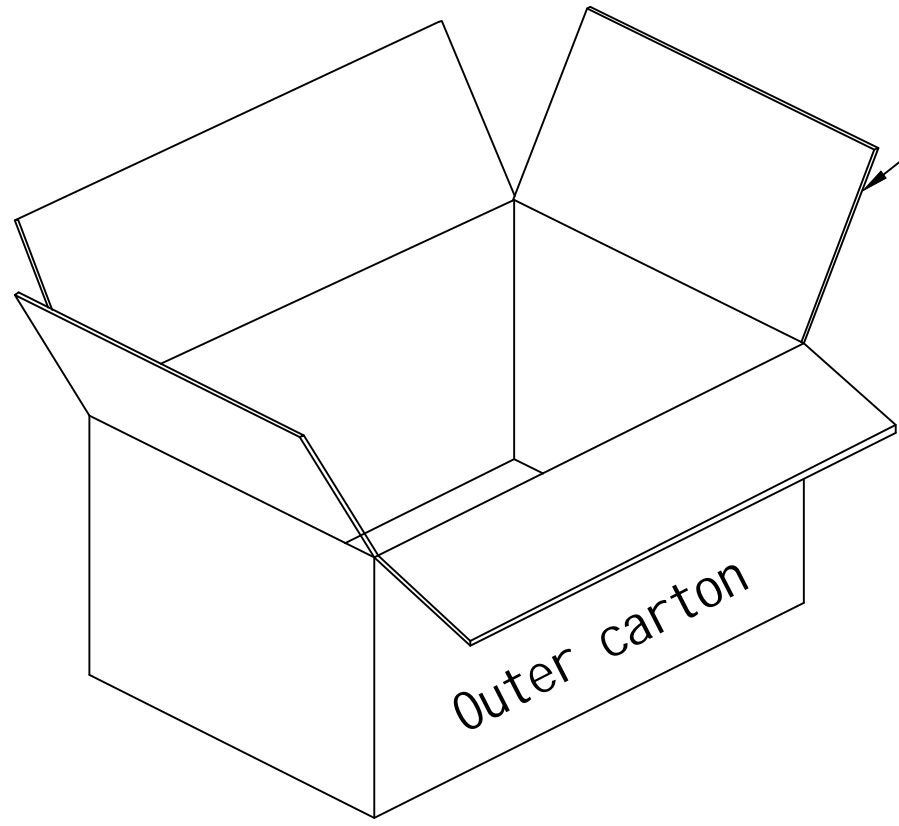
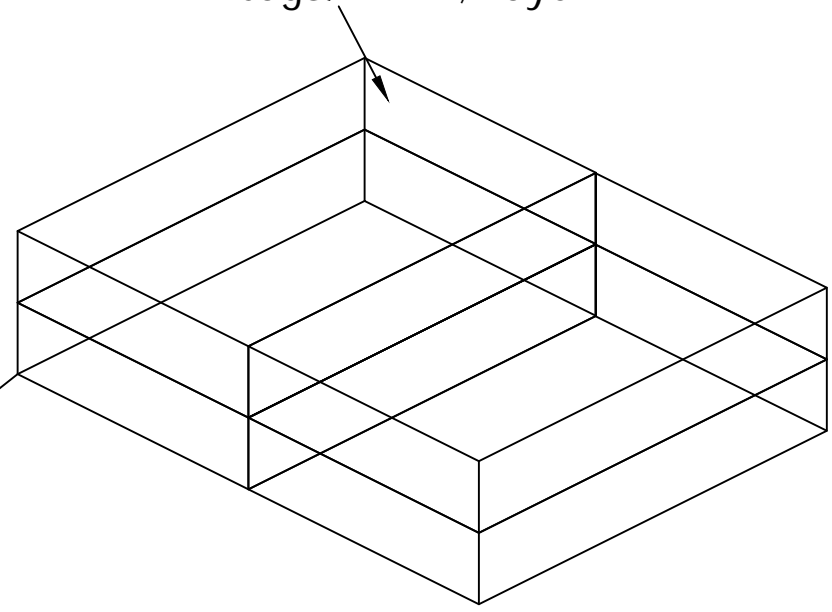

Outer carton

4 bags/layer/60PCS/CTN
Outer CTN 500*230*320mm

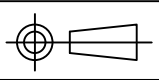
			CUSTOMER			
			PART NO			
			TITLE			
			S.H P/NO		GL088	
TOLERANCE UNLESS OTHERWISE SPECIFIED			SIZE	DRAWN	CHECKED	APPROVED
UNIT:mm	ANGLES ±0.5°	X. ±3.0	A4	Patrick	Jerry	Jammy
SHEET: 1/1	X.XX ±1.0	XX. ±5.0				
SCALE: 1/1	X.X ±2.0	2022.04.27				